

11. Schematic Diagrams

11-1 ONECHIP

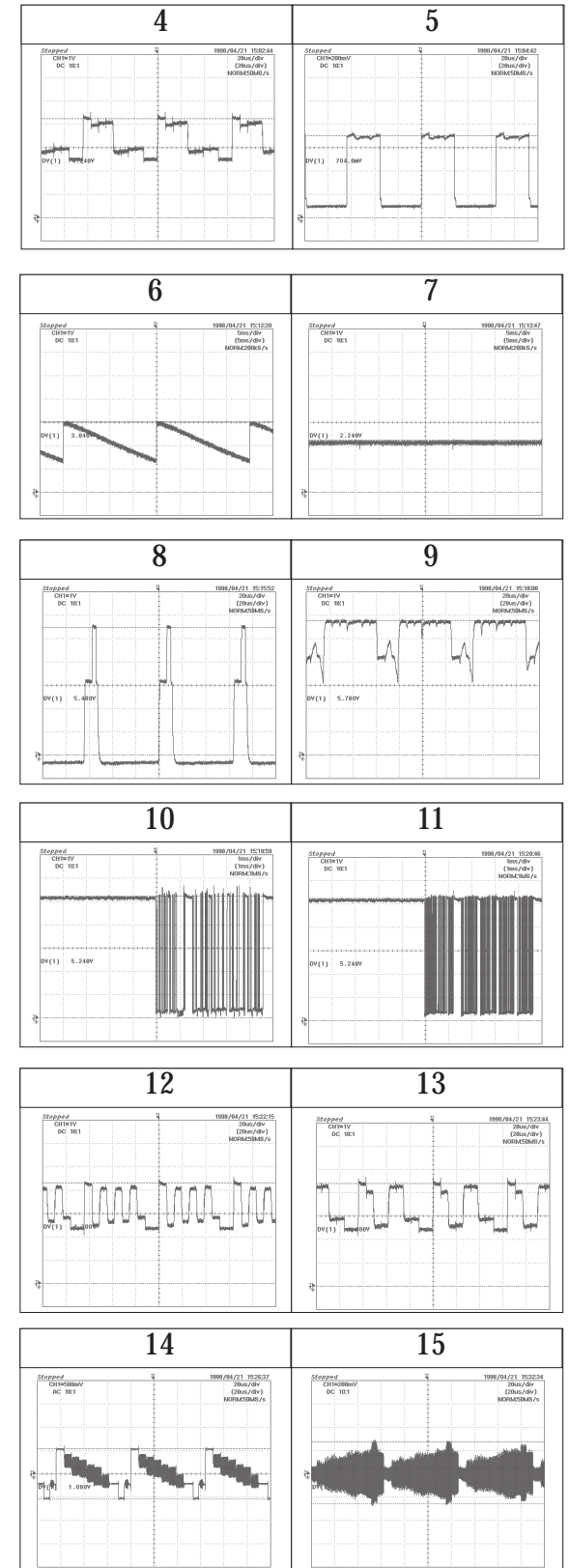

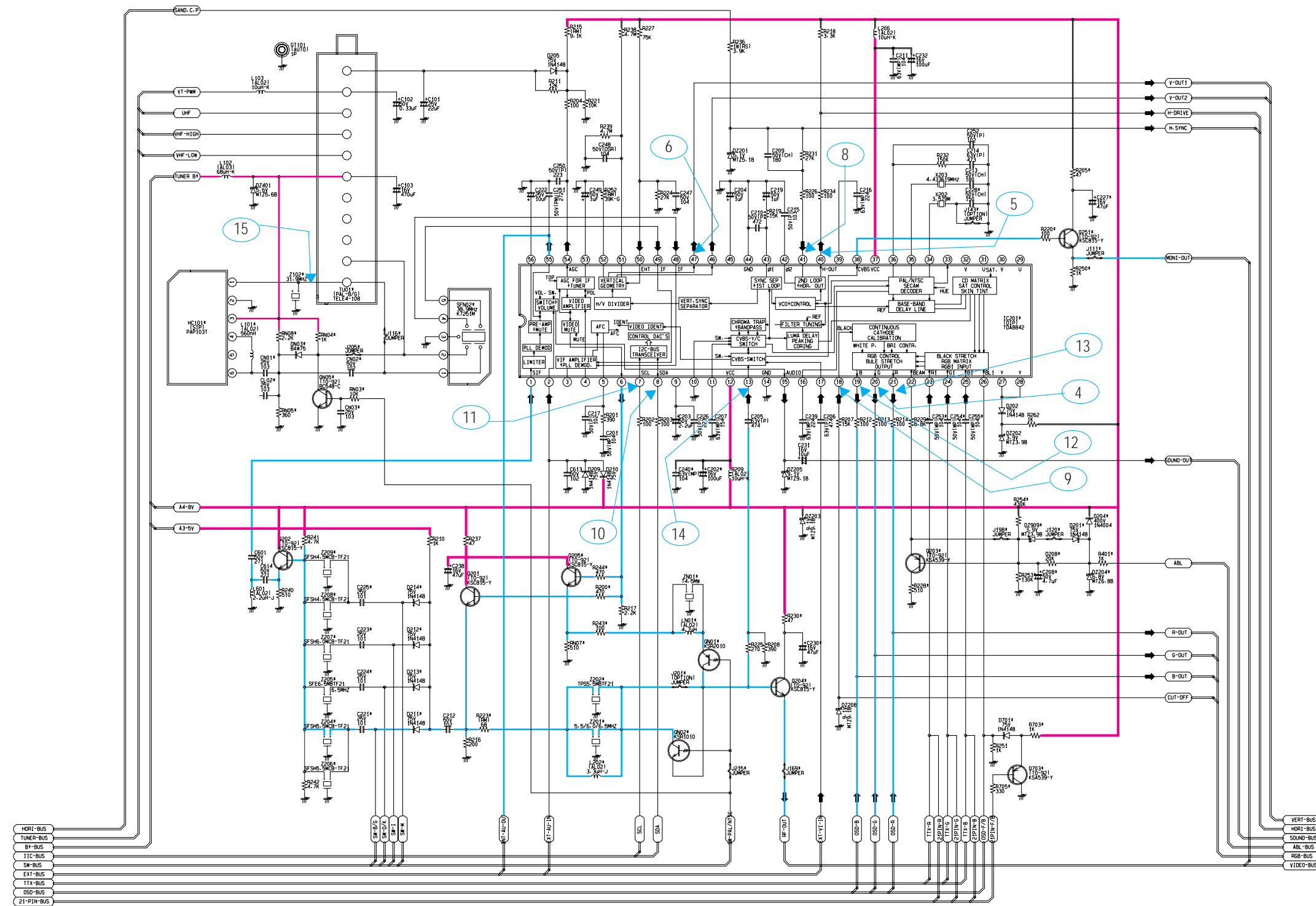
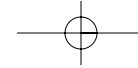

Schematic Diagrams

11-2 SOUND, EXT-A/V (Europe/Africa)

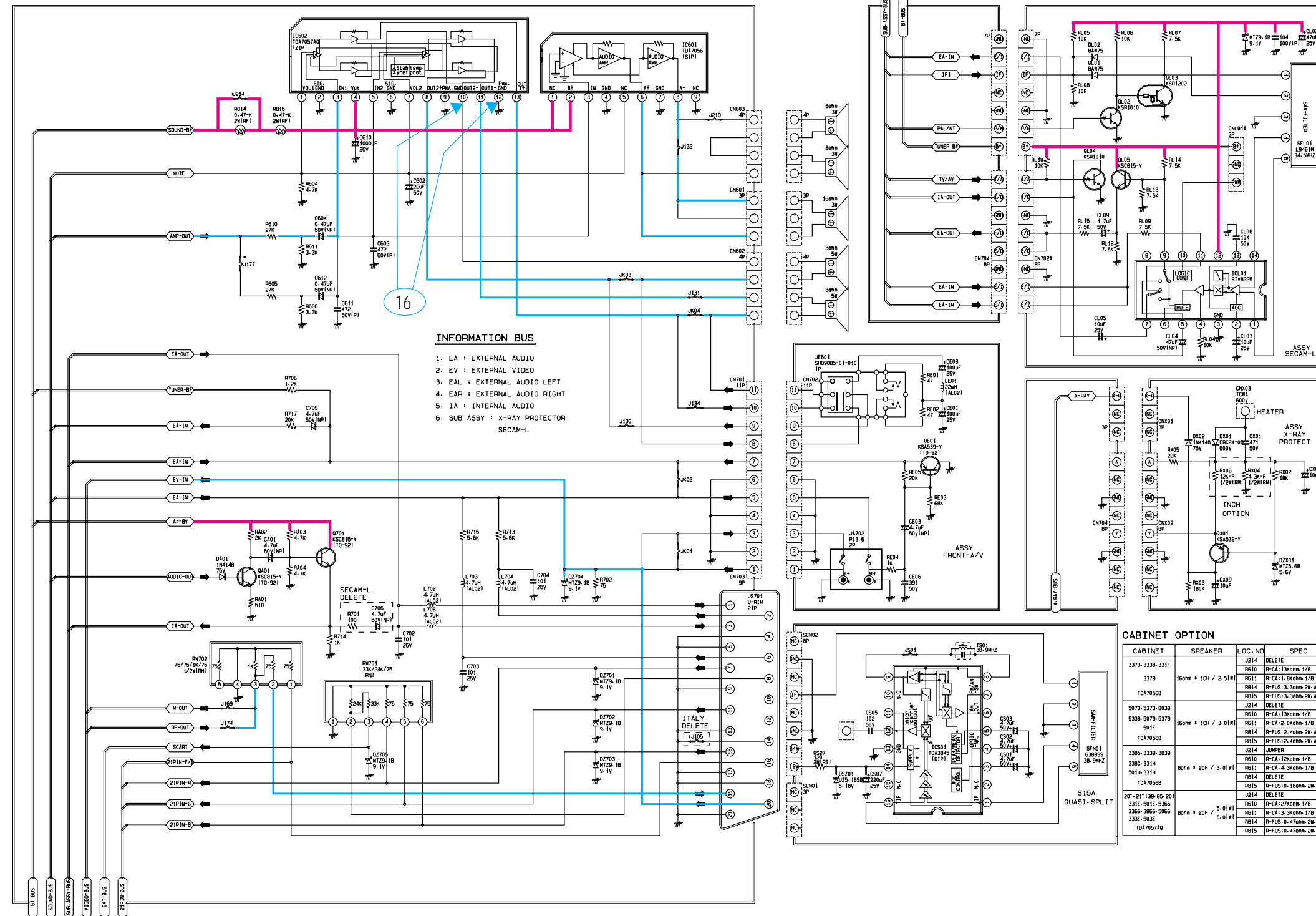

- INFORMATION BUS**
1. EA : EXTERNAL AUDIO
 2. EV : EXTERNAL VIDEO
 3. EAL : EXTERNAL AUDIO LEFT
 4. EAR : EXTERNAL AUDIO RIGHT
 5. IA : INTERNAL AUDIO
 6. SUB ASSY : X-RAY PROTECTOR SECAM-L

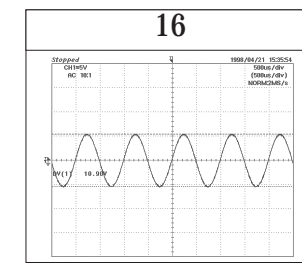

CABINET OPTION

CABINET	SPEAKER	LOC. NO	SPEC
3373-3338-331F	160mm x 100mm / 2.5" x 4"	J214	DELETE
		R610	R-CA: 1.3kΩm-1/8
		R611	R-CA: 1.8kΩm-1/8
3379	160mm x 100mm / 2.5" x 4"	R614	R-FUS: 3.300m-2W-1A
		R615	R-FUS: 3.300m-2W-1A
		J214	DELETE
5073-5373-8038	160mm x 100mm / 3.0" x 4"	R610	R-CA: 1.3kΩm-1/8
		R611	R-CA: 2.0kΩm-1/8
		R614	R-FUS: 2.400m-2W-1A
5338-5078-5378	160mm x 100mm / 3.0" x 4"	R615	R-FUS: 2.400m-2W-1A
		J214	DELETE
		J214	JUMPER
501H-331H	80mm x 200mm / 3.0" x 8"	R610	R-CA: 1.2kΩm-1/8
		R611	R-CA: 3.3kΩm-1/8
		R614	DELETE
331E-501E-536E	80mm x 200mm / 3.0" x 8"	R610	R-CA: 2.7kΩm-1/8
		R611	R-CA: 3.3kΩm-1/8
		R614	R-FUS: 0.470m-2W-1A
333E-503E	80mm x 200mm / 3.0" x 8"	R610	R-CA: 2.7kΩm-1/8
		R611	R-CA: 3.3kΩm-1/8
		R614	R-FUS: 0.470m-2W-1A

— : Power Line
 — : Signal Line

11-3 SOUND, EXT-A/V (Middle East / Asia)

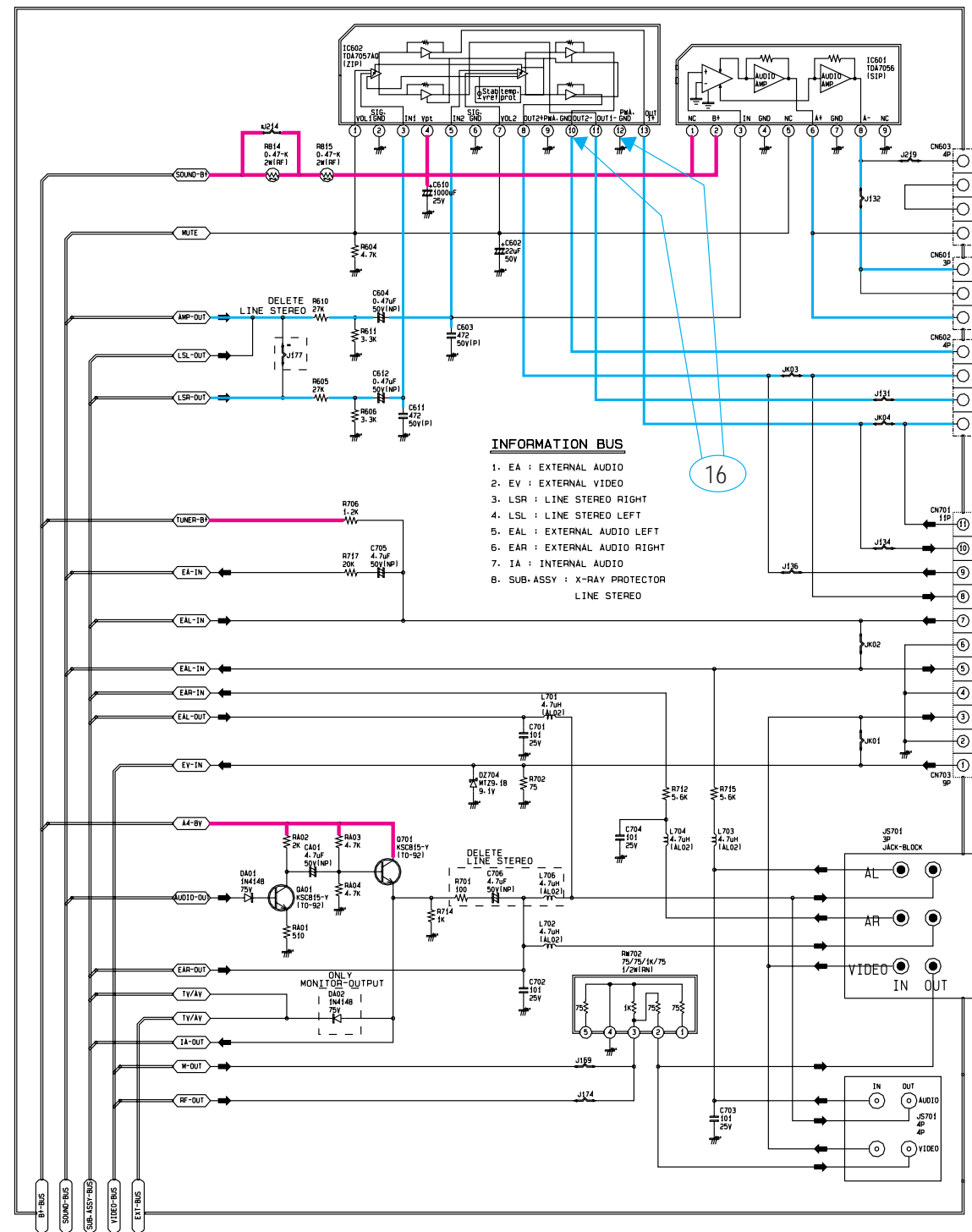

- INFORMATION BUS**
1. EA : EXTERNAL AUDIO
 2. EV : EXTERNAL VIDEO
 3. LSR : LINE STEREO RIGHT
 4. LSL : LINE STEREO LEFT
 5. EAL : EXTERNAL AUDIO LEFT
 6. EAR : EXTERNAL AUDIO RIGHT
 7. IA : INTERNAL AUDIO
 8. SUB-ASSY : X-RAY PROTECTOR LINE STEREO

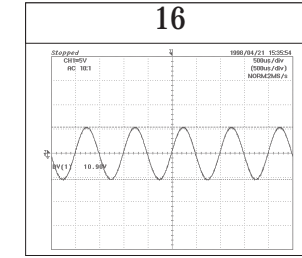
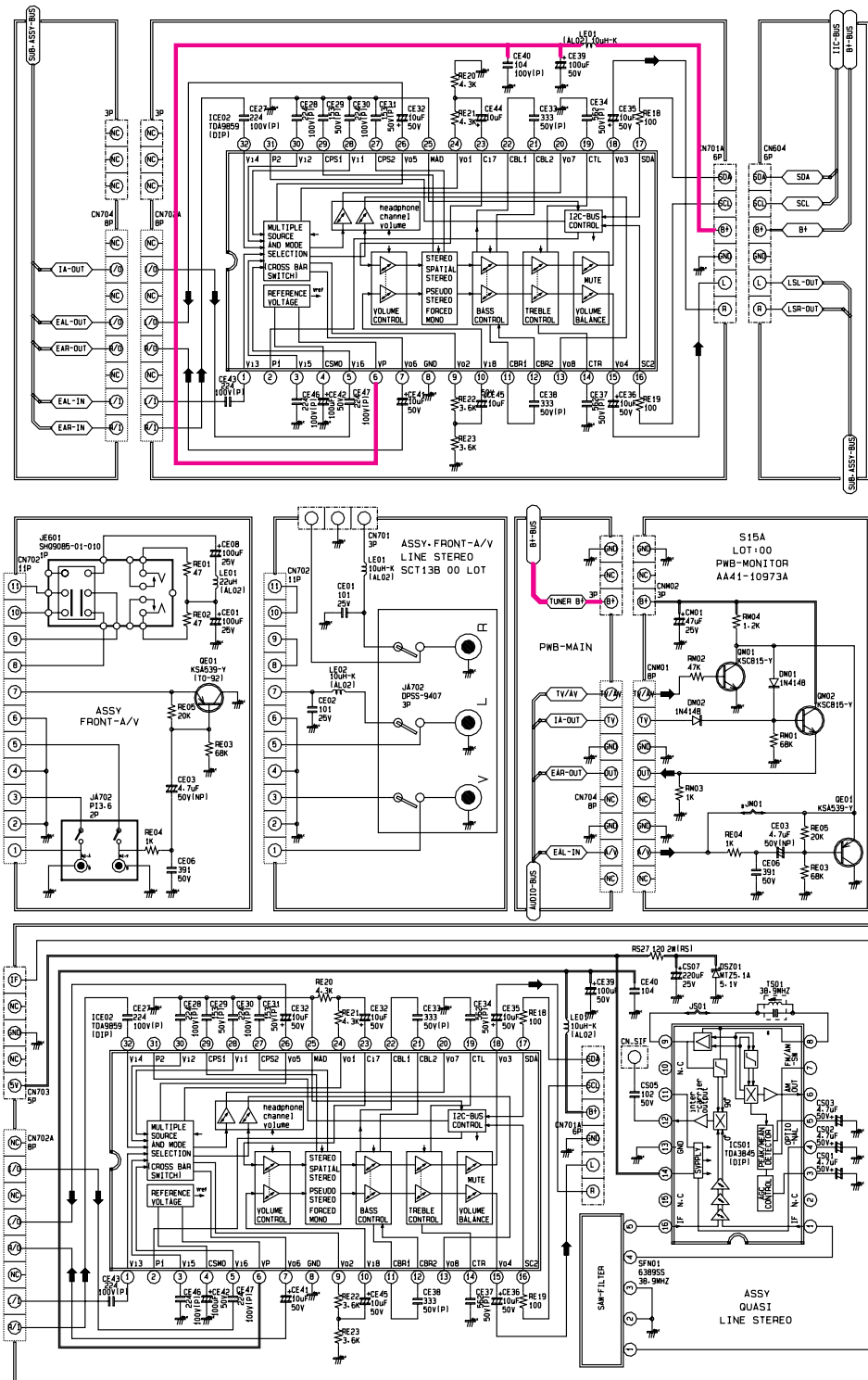

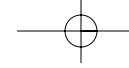

Schematic Diagrams

11-4 POWER / CRT / VERTICAL / HORIZONTAL

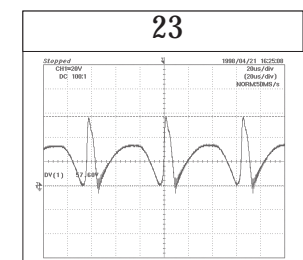
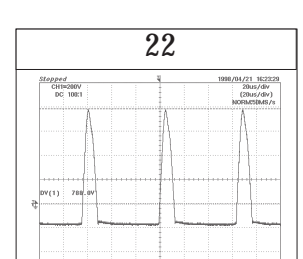
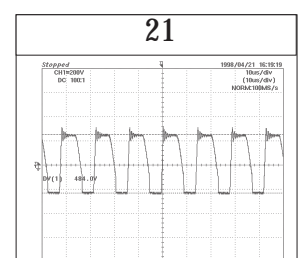
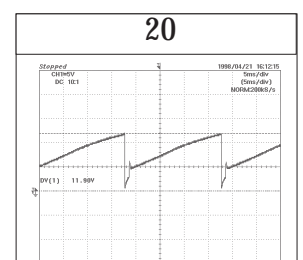
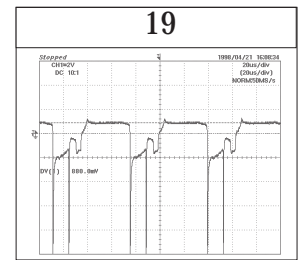
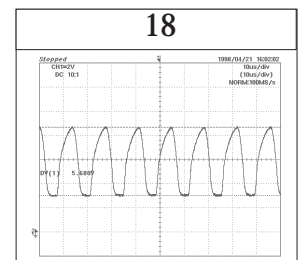
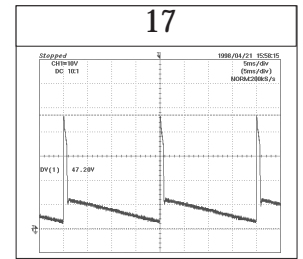
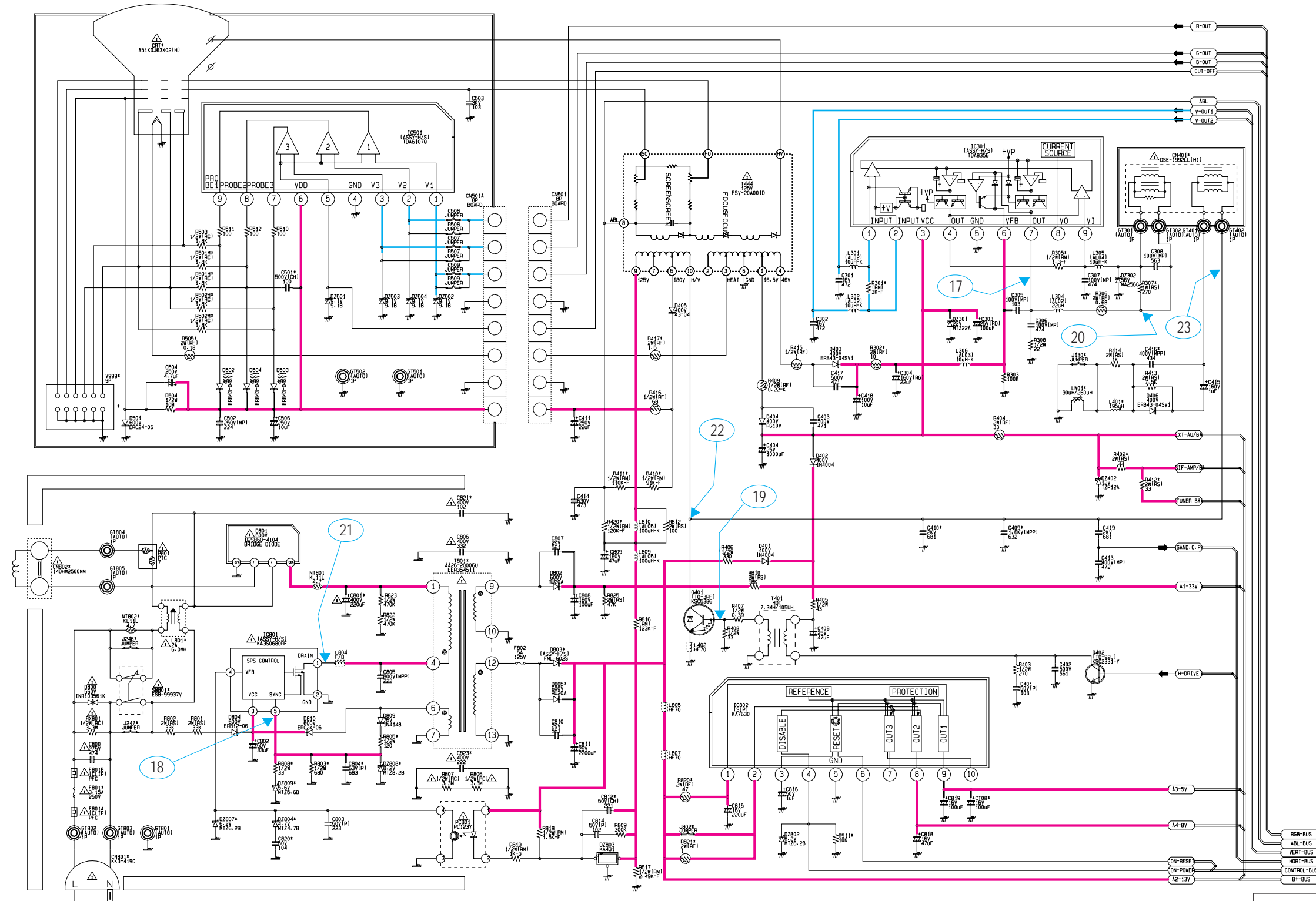

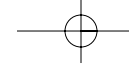

11-5 MICOM (TTX)

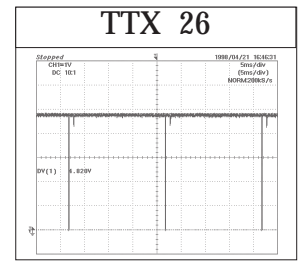
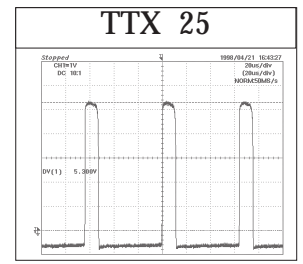
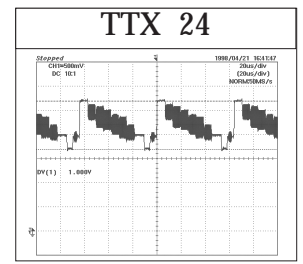
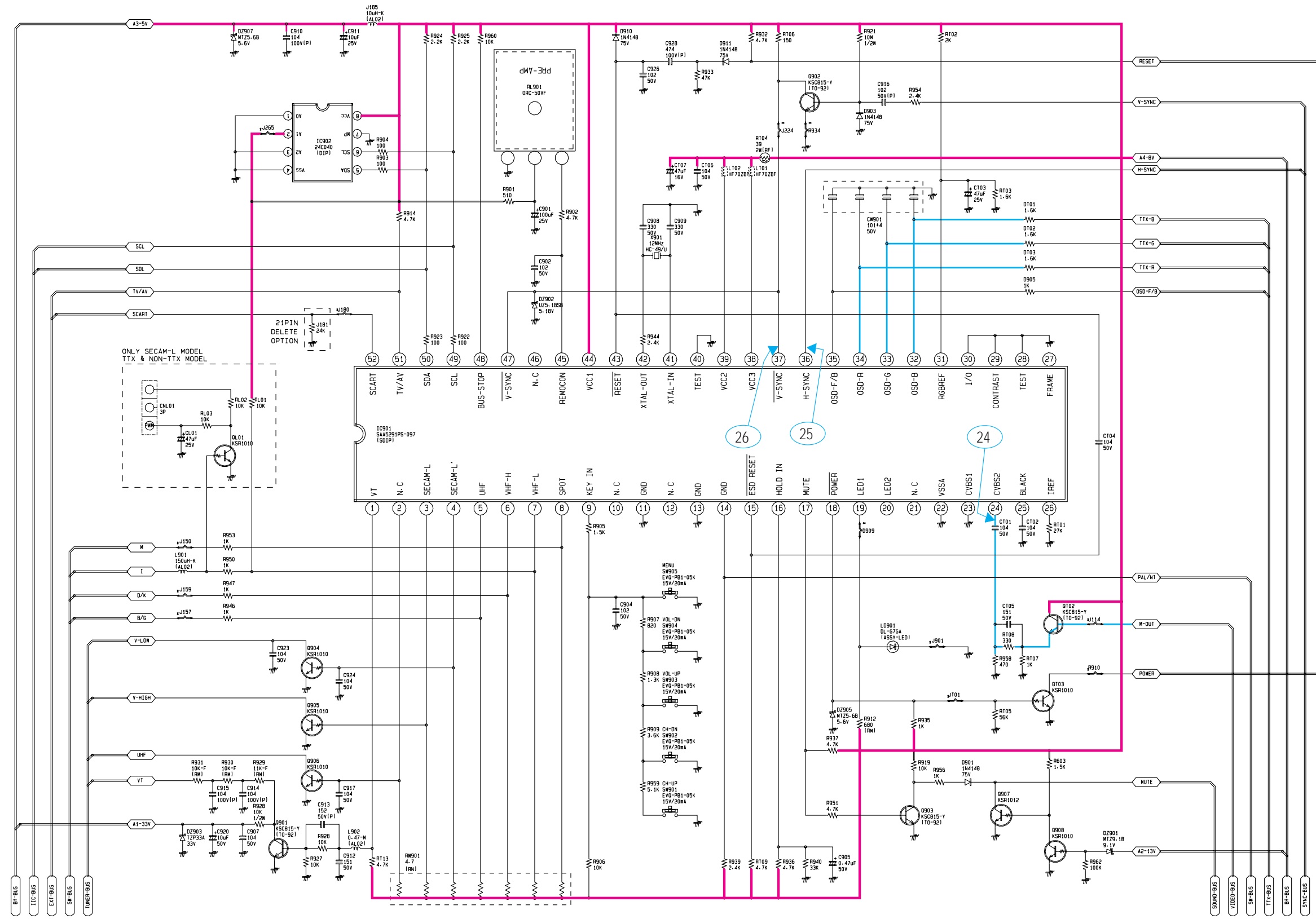

— : Power Line
 — : Signal Line

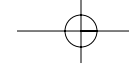

Schematic Diagrams

11-6 MICOM (NON-TTX)

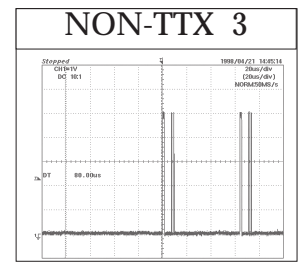
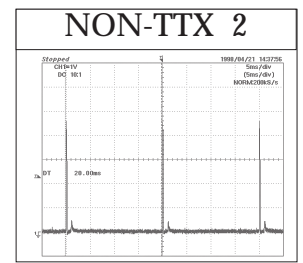
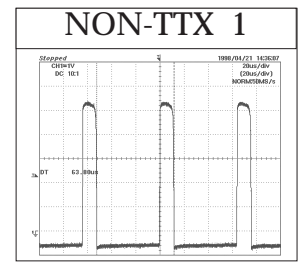
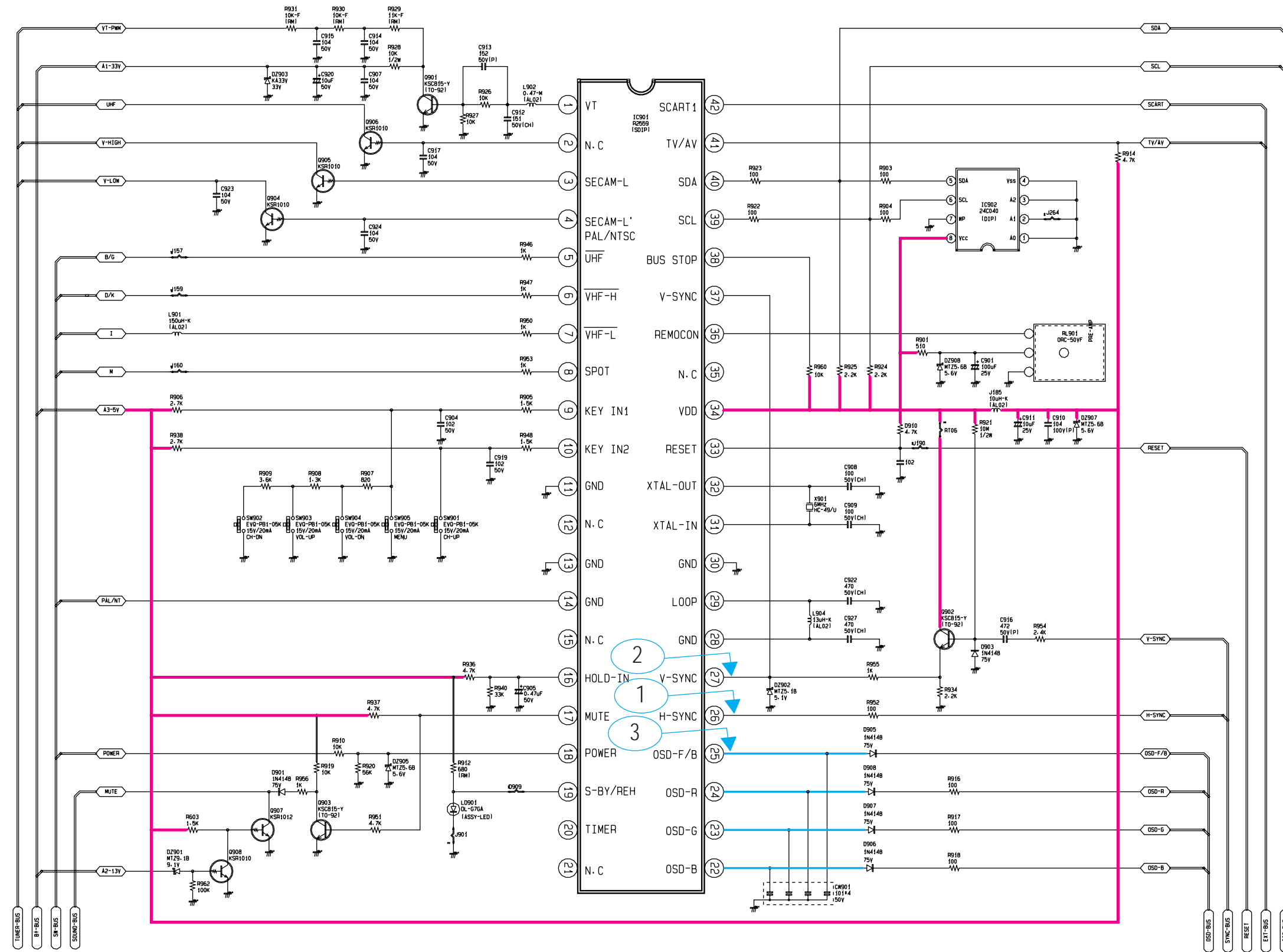

— : Power Line
 — : Signal Line